



MINIMA FX user manual

READING AND UNDERSTANDING
Instruction for use are required to use this product.



1. ⚠ WARNING

For slacklining only. Understand and accept the risks involved before participating. You are responsible for your own actions and decisions. Before using this product, read and understand all instructions and warnings that accompany it and familiarize yourself with its proper use, capabilities and limitations. Contact Equilibrium Slacklines if you are uncertain about how to use this product. Do not modify this product in any way. Check the condition of product components before and after each use. Failure to read and follow these warnings can result in severe injury or death!

Maximum tension is **8 kN**.
Minimal sag in the middle of the line:

LINE LENGTH	WEIGHT				
	50 kg	60 kg	70 kg	80 kg	90 kg
10 m	0,16	0,19	0,22	0,25	0,28
20 m	0,31	0,38	0,44	0,50	0,56
30 m	0,47	0,56	0,66	0,75	0,84
40 m	0,63	0,75	0,88	1,00	1,13
50 m	0,78	0,94	1,09	1,25	1,41
60 m	0,94	1,13	1,31	1,50	1,69
70 m	1,09	1,31	1,53	1,75	1,97
80 m	1,25	1,50	1,75	2,00	2,25

TENSION = 8 kN

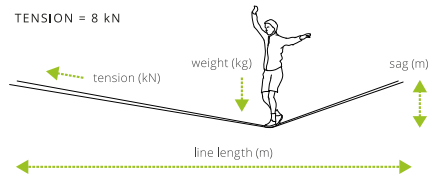

! MINIMA is not certified for usage in heights. Do not use this device higher than 1 m above the ground.

2. DESCRIPTION

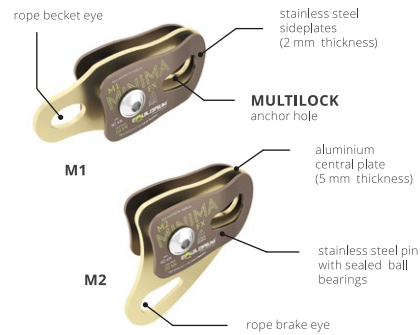

Minima pulley system is specially designed for slacklining. Thanks to the "sheaveless" solution the dimensions of the whole system are minimized. The basic combination of Minima pulleys creates a rigging system with the mechanical advantage of 5:1. Straight sideplates and outer width of 26 mm allow you to attach the pulley system directly to a 12 mm shackle or any standard 1" webbing locker. Optimal efficiency of the whole system is provided by used sealed ball bearings which distribute the load equally to each strand of pulley system rope.

3. SAFETY RECOMMENDATIONS

Always tie a stopper knot on the loose tail of rope (the piece of rope that comes out of the rope brake) to prevent slipping of the rope under high tensions. Always backup the device with a separate sling or a piece of rope to a secure anchor to prevent the metal parts flying around in case of the anchor failure. If you lack experience, use this equipment under proper supervision.

4. INSTRUCTION FOR USE

PULLEY M-1:

Rope attachment:

Connect the sewn loop on the end of rigging rope with the becket eye (1) on the pulley M-1.

Locker attachment:

Unscrew the rear axis of Bandit (resp. other 1" webbing locker). Connect the main anchor eye of the pulley M-1 (2) with the rear axis of the locker (bolt with the distance tube).

PULLEY M-2:

Pulley attachment:

To attach the M-2 pulley to the anchor (sling, spanset etc.) use a 1/2" bow shackle (inner width 26 mm) that you connect to the main anchor eye (3).

Rope brake attachment:

Attach the Elephant brake with a 6 mm shackle to the brake eye (4). You can attach any other 8 mm rope brake via the 8 mm steel shackle.

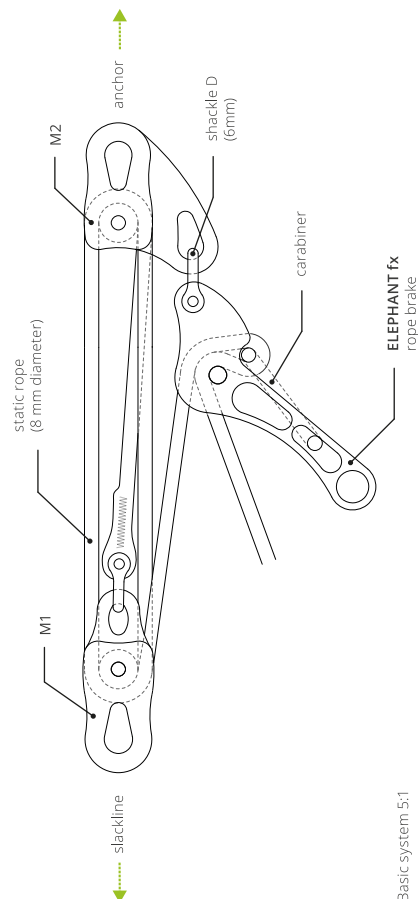
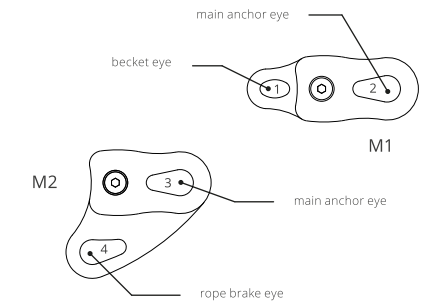

Basic system 5:1

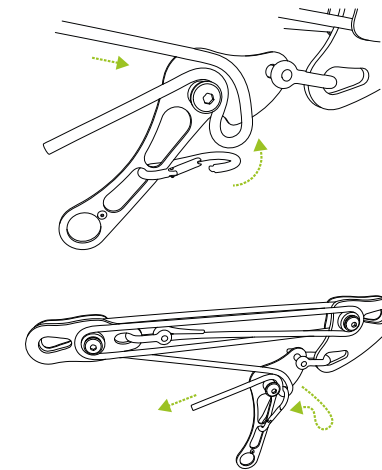
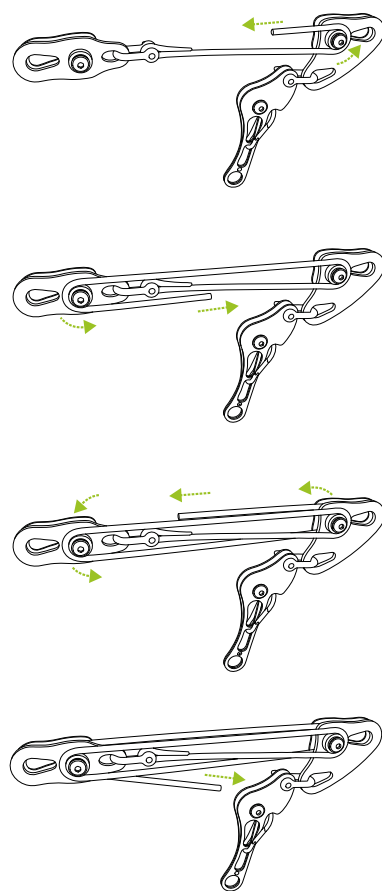

Make sure that the carabiner is correctly positioned in the groove to achieve an adequate braking effect.

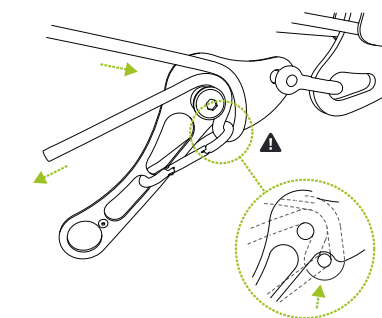

5. CARE AND MAINTENANCE

Slacklining gear must not come into contact with corrosive materials such as battery acid, battery fumes, solvents, chlorine bleach, antifreeze, isopropyl alcohol or gasoline.

After contact with saltwater or salt air, always rinse the product with fresh water and dry it perfectly. Store in a dry place.

6. SPECIFICATION

MINIMA FX TECHNICAL SPECIFICATIONS:	
maximum load	8 kN
minimal breaking strength	40 kN
weight (M1 + M2)	364 g
dimensions	110 x 42 x 45 mm
ball bearing diameter	22 mm
inner width	10 mm

7. CONTACTS

Need help? Any questions?
Comments, compliments, complaints?

Check out www.eqb.cz or write us at info@eqb.cz

This product was completely designed by handsome slackliners and manufactured in the Czech Republic.